

1

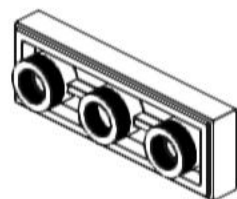

2

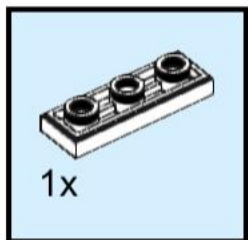
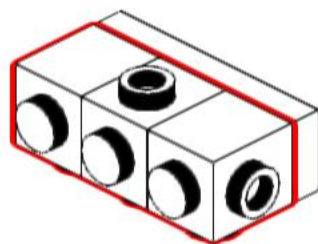
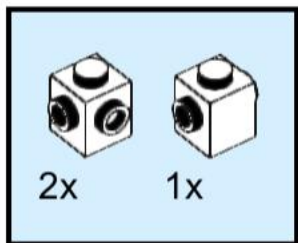

3

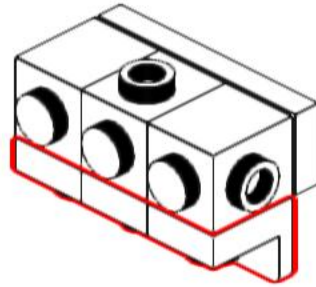
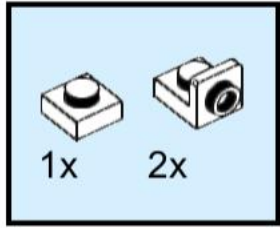

4

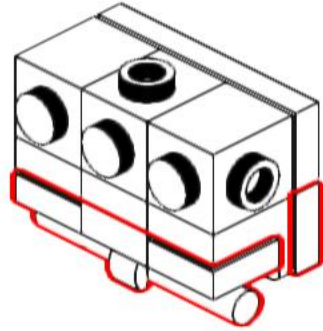
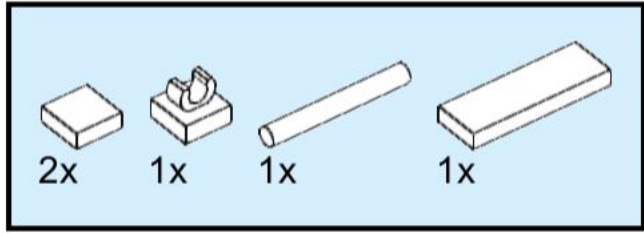

5

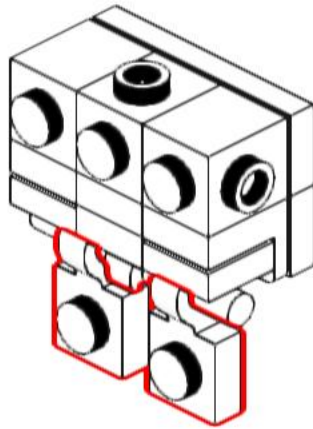
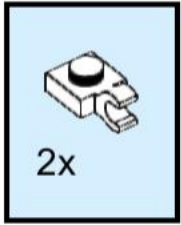

6

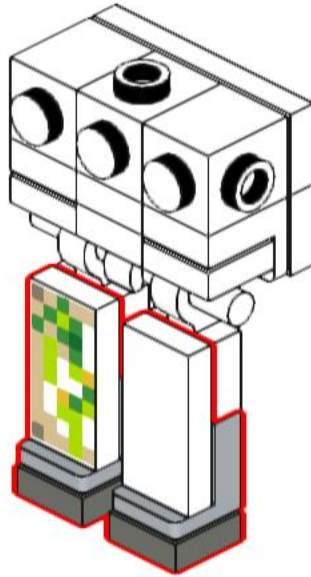
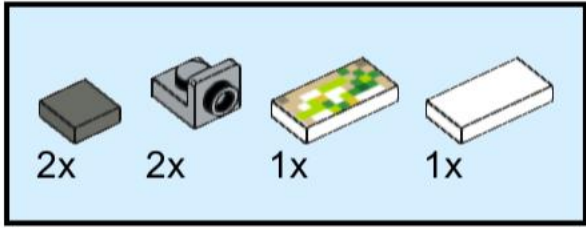

7

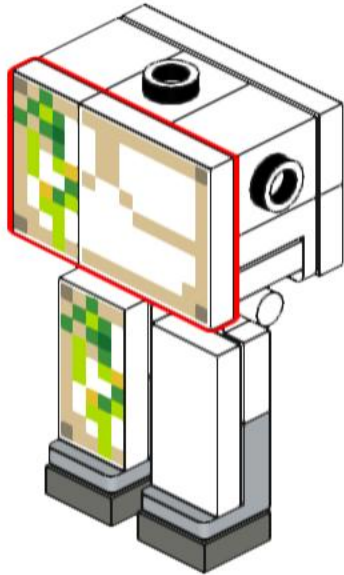
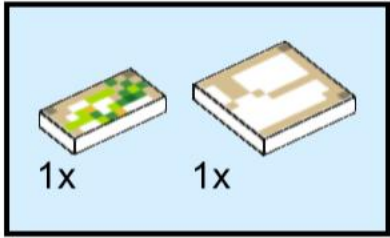

8

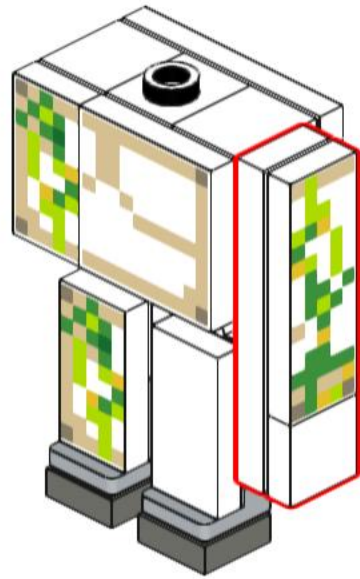
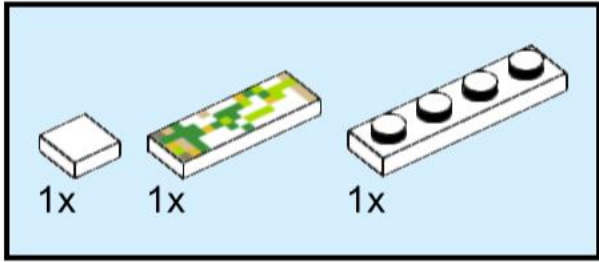

9

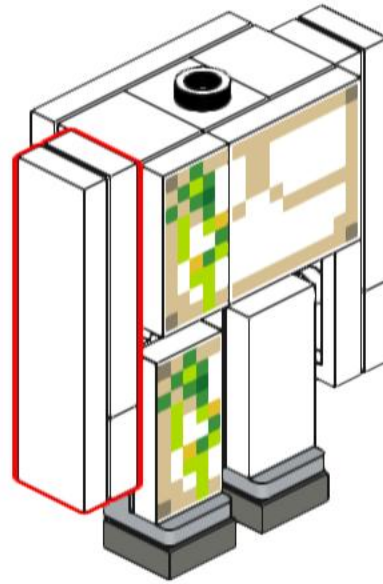
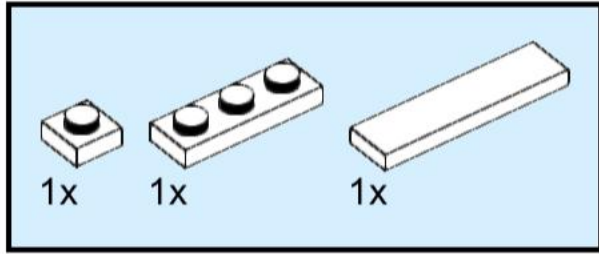

10

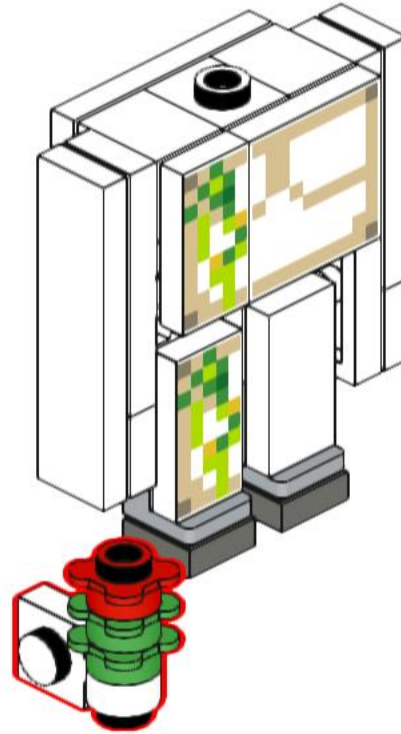
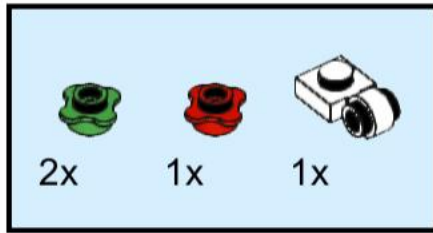

This hand can be swapped out with the right arm to have the Iron Golem be holding a flower!

11

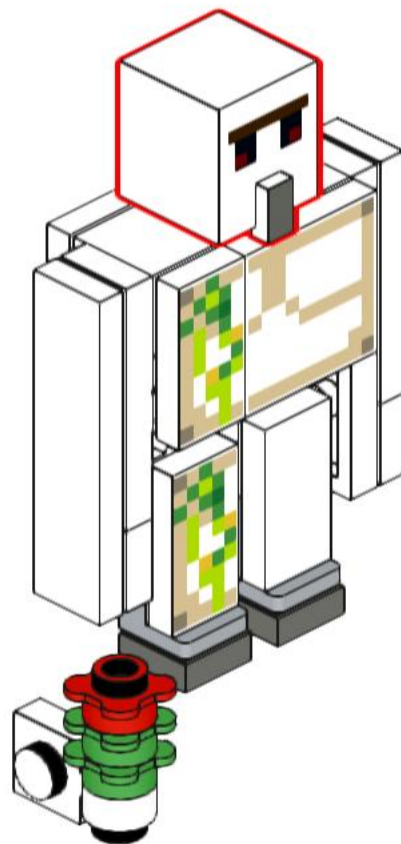
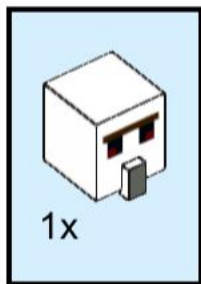

12

